

AC INFINITY

CLOUDLINE

MIXED FLOW INLINE FAN SYSTEMS

USER MANUAL

WELCOME

Thank you for choosing AC Infinity. We are committed to product quality and friendly customer service. If you have any questions or suggestions, please don't hesitate to [contact](#) us. Visit www.acinfinity.com and click contact for our contact information.

EMAIL

support@acinfinity.com

WEB

www.acinfinity.com

LOCATION

Los Angeles, CA

MANUAL CODE CL2109X2

PRODUCT

CLOUDLINE S4
CLOUDLINE S6
CLOUDLINE S8
CLOUDLINE S10
CLOUDLINE S12
CLOUDLINE T4
CLOUDLINE T6
CLOUDLINE T8
CLOUDLINE T10
CLOUDLINE T12

MODEL

AI-CLS4
AI-CLS6
AI-CLS8
AI-CLS10
AI-CLS12
AI-CLT4
AI-CLT6
AI-CLT8
AI-CLT10
AI-CLT12

UPC-A

819137020290
819137020306
819137020849
819137020856
819137021006
854759004785
854759004792
819137020276
819137020283
819137021013



EC models CANNOT be daisy chained with DC models. See page 19 & 20 for more information on daisy-chaining fans and safety precautions.

MANUAL INDEX

Manual Index	Page 5
Key Features	Page 6
Product Contents	Page 7
Installation (Mounting)	Page 9
Installation (Hanging)	Page 14
Installation (Motor Cap Orientation)	Page 18
Installation (Configuration Setup)	Page 19
Powering and Setup	Page 20
Adding More Fans	Page 23
Cleaning	Page 24
Programming	Page 26
Other Settings	Page 40
Download the App	Page 41
Add a Device	Page 42
App Programming.....	Page 44
App Settings.....	Page 54
FAQ	Page 55
Other AC Infinity Products	Page 57
Warranty	Page 58

KEY FEATURES

QUIET PWM MOTOR

PWM-controlled motor features precise speed control, reduced rotor noise, and energy-efficient EC voltage.

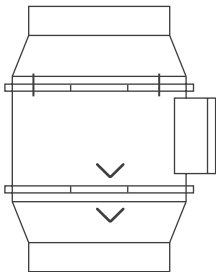

IP-44 PROTECTION

The inline duct fan is sealed to Ingress Protection 44 standards, rated with high resistance to liquids and dust.

STATOR BLADE FANS

Hydro-mechanical stator blades enable efficient airflow delivery in high static pressure environments.

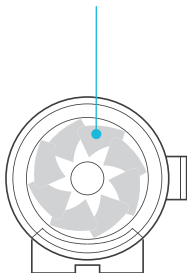

DUAL BALL BEARINGS

The motor contains ball bearings with an estimated 67,000 hour lifespan. Enables the fan to be mounted in any direction.

SMART CONTROLLER

Features automation controls that activate the fan according to temperature, humidity, timer, and schedules.

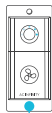
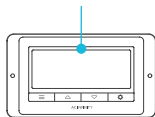

SPEED CONTROLLER

Single button controller with circular readout display that enables fan speed control in eight speeds.

PRODUCT CONTENTS

CLOUDLINE S-Series



SPEED
CONTROLLER
(x1)



MACHINE SCREWS
(WALL MOUNT)
(x2)



WOOD SCREWS
(WALL MOUNT)
(x2)

CLOUDLINE T-Series



SMART
CONTROLLER
(x1)



SENSOR
PROBE
(x1)



MACHINE SCREWS
(WALL MOUNT)
(x2)



WOOD SCREWS
(WALL MOUNT)
(x2)



WOOD SCREWS
(WALL HANG)
(x2)

FAN UNIT (Included in both S-Series and T-Series)



DUCT FAN
SYSTEM
(x1)



DUCT
CLAMP
(x2)

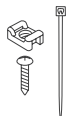

WIRE
MOUNT
(x6)

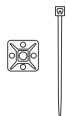

PROBE
MOUNT
(x1)



VELCRO
TIES
(x4)



WALL
ANCHOR
(x4)



HANGING
STRAPS
(x2)



DUCT FAN
SCREW SET
(x4)

PRODUCT CONTENTS

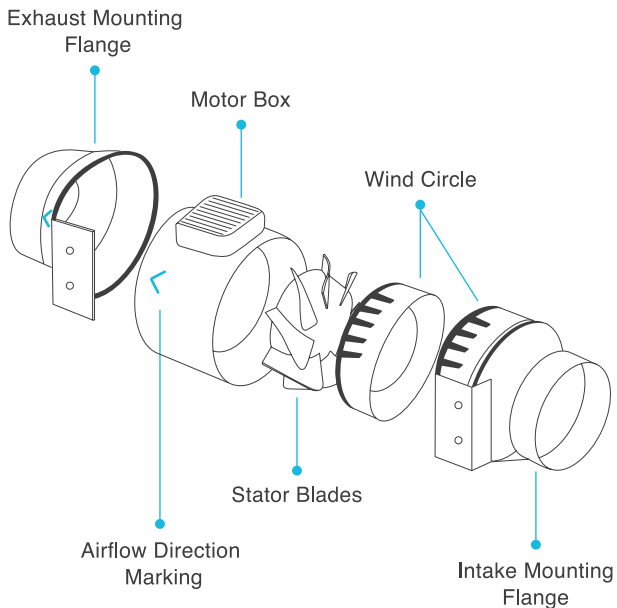

INSTALLATION

MOUNTING

STEP 1

Unscrew and loosen the metal rings using a Phillips screwdriver and pliers.

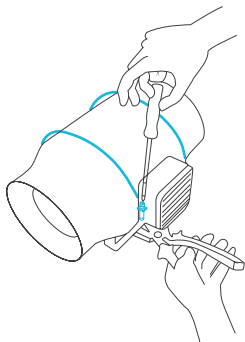

STEP 2

Remove the motor box from the flange bracket.

Remove the wind circle between the motor box and the intake flange.

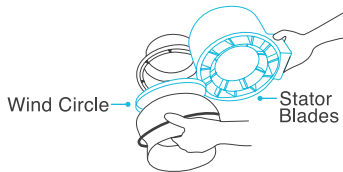
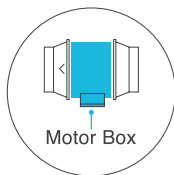

INSTALLATION

MOUNTING

STEP 3

Use the flange bracket to set your desired fan position. Mark the four mounting holes.

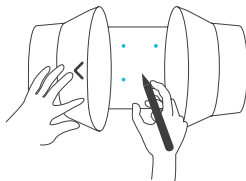

STEP 4

Drill four holes into the marked locations. Make sure your mounting area is structurally sound and free from obstruction.

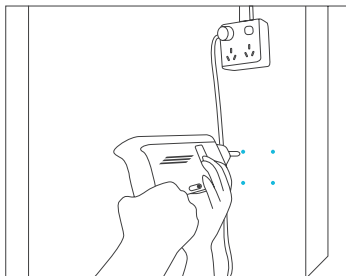

INSTALLATION

MOUNTING

STEP 5

If you are mounting onto anything other than a wood support or stud, insert the included four wall anchors into the drilled mounting holes.

You may need to use a hammer to secure them through the holes.

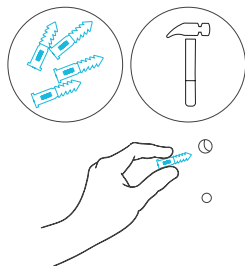

STEP 6

Align the flange bracket's holes with the wall anchors. Screw in four wood screws with a screwdriver or drill to secure the flange bracket.

Make sure its airflow arrow is pointing in your desired direction.

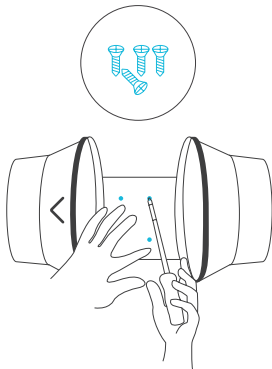

INSTALLATION

MOUNTING

STEP 7

Place the wind circle back into the intake flange and reposition the metal clamps over the flanges if applicable.

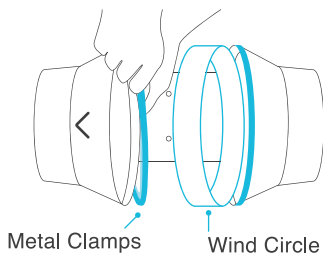

STEP 8

Slide the motor box back into the flange bracket, making sure its airflow arrow is pointing in the same direction as the flange bracket's arrow.

Tighten the metal clamps using a Phillips screwdriver and pliers to secure the motor box.

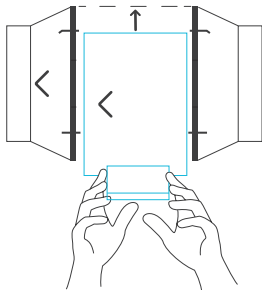

INSTALLATION

MOUNTING

STEP 9

Place the metal rings back onto the flanges and tighten the screws back to secure the fan.

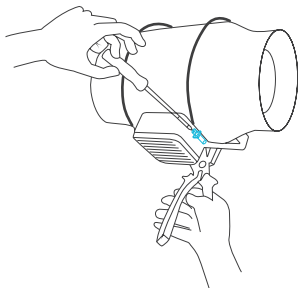

STEP 10

If installing ducting, use the included duct clamps to secure it to either end of the duct fan, making sure there is a tight seal.

Tighten the duct clamps using a flathead screwdriver.

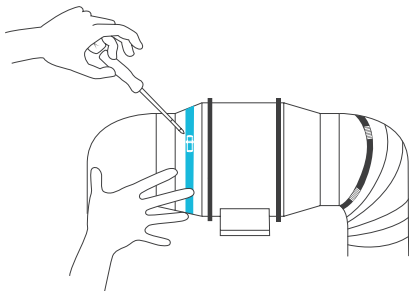

INSTALLATION

HANGING - ROPE CLIPS

STEP 11(a) - Hanging Upward

If installing with rope hangers (sold separately), loop the ropes around the flanges and tighten the rope to secure the fan.

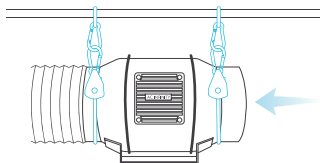

STEP 11(b) - Hanging Downward

Loop the two rope hangers around a pole and the fan's bracket.

Clip the carabiners onto each other. Shorten the loops as needed.

Make sure the fan's airflow arrow is pointing towards your desired direction.

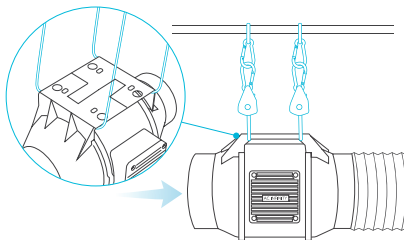

INSTALLATION

HANGING - STRAPS

STEP 1

Loop the strap around the bracket and a pole.

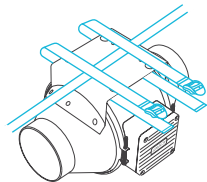

STEP 2

Slip the strap through the inner ladder lock slot from the bottom.

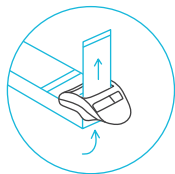

INSTALLATION

HANGING - STRAPS

STEP 3

Route the strap into the outer ladder lock slot from the top. Adjust the length of the completed loop as needed.

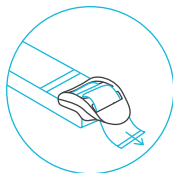
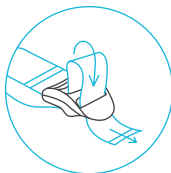

Adjust to size

STEP 4

Tuck the loose end through the center gap of the ladder lock to secure the loop.

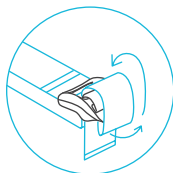

Loop through middle
to lock in place

INSTALLATION

HANGING - STRAPS

STEP 5(a) - Hanging Downward

Let the fan hang by the pole once the straps are secure.

Make sure the fan's airflow arrow is pointing towards your desired direction.

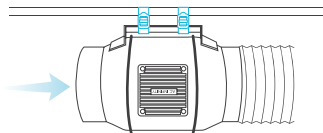

STEP 5(b) - Hanging Upward

To hang the fan right-side up, loop and tighten the straps, as shown in steps 1-4, around the pole.

Hang the fan by the duct flanges to secure it.

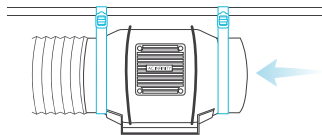

INSTALLATION

MOTOR CAP

STEP 1

Unscrew the motor cap using a screwdriver.

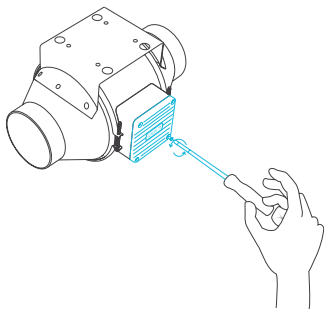

STEP 2

Rotate the motor cap to your desired orientation. Reapply the screws.

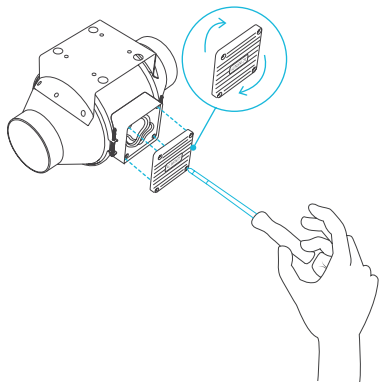

Rotating the motor cap will not void your warranty.

INSTALLATION

CONFIGURATION SET-UP

Intake and Exhaust

This fan can be used as either an intake fan or an exhaust fan in grow rooms and larger grow tents. To achieve optimal whole space ventilation, the intake fan or opening - if not using a fan - must be situated at a bottom corner of your grow space. The exhaust fan must be hung (shown below) or mounted at the highest opposite corner possible.

Make sure the intake fan's airflow arrow is pointing towards your grow space and the exhaust fan's arrow pointing away from your grow space.

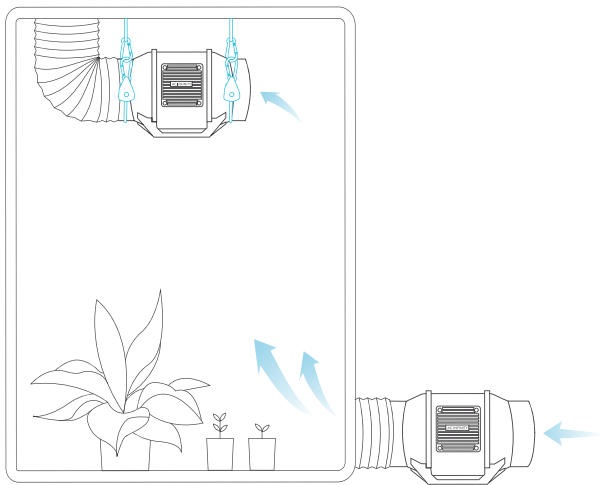

POWERING AND SETUP

S-SERIES

STEP 1

Plug the duct fan's 4-pin molex connector into the speed controller's port at the top.

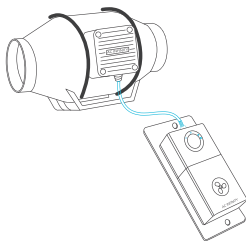

STEP 2

Plug the fan's power cord into a wall outlet. The controller will receive power from the fan to operate. (EC Motor fans only)

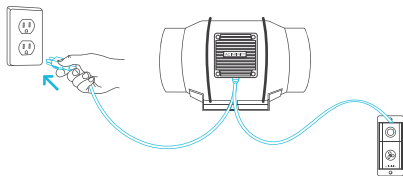

POWERING AND SETUP

T-SERIES

STEP 1

You may cable manage the cords using tie mounts, wood screws, and zip ties included with this fan.

Secure the tie mounts onto a surface using the wood screws. Loop the zip ties around the cords into the tie mounts.

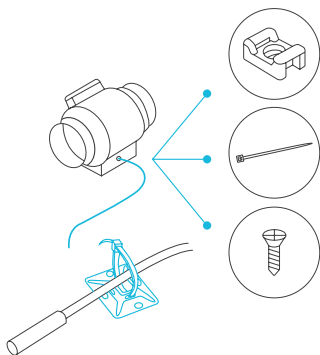

STEP 2

Plug the duct fan's 4-pin molex connector into the universal controller's left port signified by the fan/power symbol.

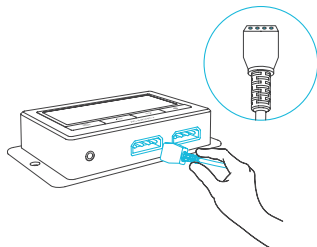

POWERING AND SETUP

T-SERIES

STEP 3

Plug the sensor probe into the controller's 3.5mm jack. Set the probe near your plants in your grow tent for the most accurate reading.

Keep the probe cord away from your HID* grow light ballast's power cord to ensure the controller properly detects climate conditions.

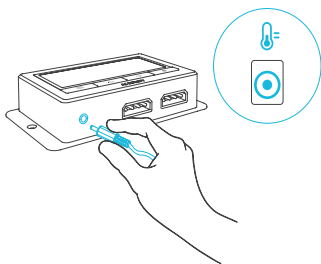

*MH, HPS, CMH, or CHPS

STEP 4

Plug the fan's power cord into a wall outlet. Make sure it is plugged into one that is separate from your grow light's outlet.

The controller will receive power from the fan to operate. (EC Motor fans only)

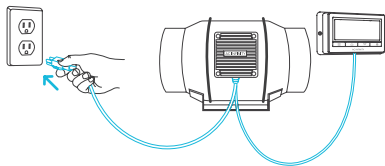

ADDING MORE FANS

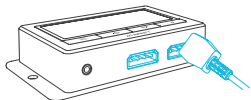

The smart controller for the CLOUDLINE T-Series has an additional port so that you can add an S-Series fan to power and control two fans together. [Please see below for limitations.](#)

T-SERIES CONTROLLER

Smart controllers for T-Series models with EC motors can support two fans of any size. The two EC-motor fans must be plugged in to an outlet to power the fans and the controller. See images below.

EC MOTOR

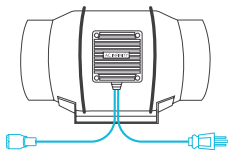

EC models have two cords with a molex connector and a three-pronged plug.

Dual Connection

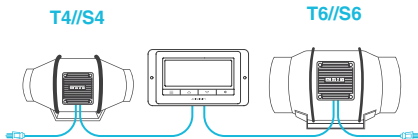

EC models can connect two fans of any size fan.

CLEANING

STEP 1

Remove the motor box from the mounting flange. Refer to steps 1-2 on page 9 to learn how to remove the motor box.

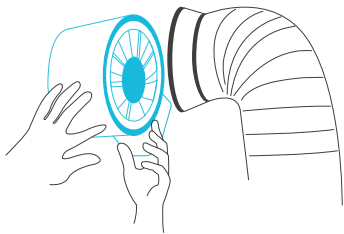

STEP 2

Use a damp cloth to clear the impeller and fan blades of any dust and debris. Remove the wind circle in between the motor box and input flange.



CLEANING

STEP 3

Clear the stator blades of any dust and debris on the opposite end. Clean the area inside the output and exhaust flanges.

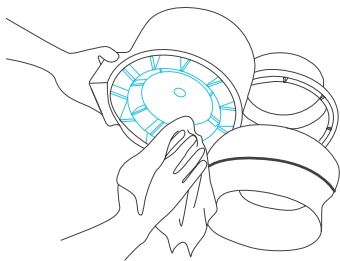

STEP 4

Secure the motor box onto the mounting flanges. Refer to steps 7-9 on page 12-13 to learn how to secure the motor box.

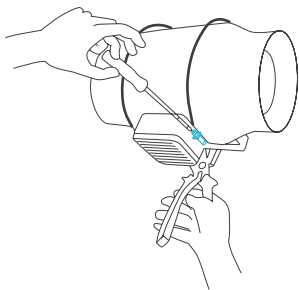

PROGRAMMING

FAN SPEED ADJUSTING

The controller features a single button that controls the fan speed from 0-8. Pressing the speed button increases the fan speed in one unit increments. Pressing the button at the 8 setting will set the fan speed back to 0.

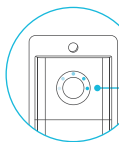
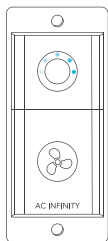

Fan Speed Indicator

POWERING ON/OFF

Holding the speed button for 4 seconds will turn the fan OFF. Pressing it again from OFF will turn the fan ON at its last speed setting.

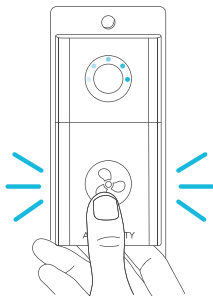

PROGRAMMING

1. MODE BUTTON

Cycles through the controller's available modes: OFF, ON, AUTO (4 triggers), TIMER TO ON, TIMER TO OFF, CYCLE (On and Off), and SCHEDULE (On and Off).

4. STATUS ICONS

Flashes or displays the alert icons from the controller. Icons include Timer Alert and Display Lock.

6. CONTROLLER MODE

Displays the controller's current mode. Pressing the mode button cycles through the available modes.

9. CURRENT TIME

Displays the current time. The internal battery sustains the clock so it does not default to 00:00 if power is cut off. Please see page 34 for instructions on how to set up the clock time.

2. UP/DOWN BUTTONS

Adjusts the value of your current mode. The up button increases and down button decreases the setting. Hold both to reset values to OFF or 0.

7. PROBE TEMPERATURE

Displays the current temperature that the probe is detecting. Shows "--" if no probe is plugged in. Includes a trend indicator that signals a rise, steady, or fall in temperature within the last hour.

10. FAN SPEED

Displays the current speed in which the fan is running. Includes a trend indicator that signals if the fan is currently rising, falling or holding steady.

3. SETTING BUTTON

Cycles through the controller's available settings: DISPLAY, °F/ °C, CLOCK, CALIB. T°/ H%, and TRANS. T°/ H%.

5. USER SETTING

Displays the value of your current mode. Use the up and down buttons to adjust the value.

8. PROBE HUMIDITY

Displays the current humidity that the probe is measuring. Shows "--" if no probe is plugged in. Includes a trend indicator that signals a rise, steady, or fall in humidity within the last hour.

11. COUNTDOWN

Displays the countdown of the TIMER TO ON, TIMER TO OFF, CYCLE, or SCHEDULE modes. TO ON shows the amount of time left before the fan turns on. TO OFF shows the amount of time left before the fan turns off.

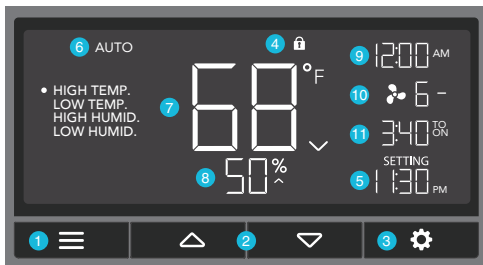

PROGRAMMING

CONTROLLER MODES

Pressing the mode button will cycle through the controller's available programming modes: OFF, ON, AUTO (4 triggers), TIMER TO ON, TIMER TO OFF, CYCLE (On and Off), and SCHEDULE (On and Off).

OFF MODE

Your fan will not run while in this mode. The fan speed set while in this mode establishes the minimum speed in other modes. When the fan is triggered to turn OFF in all other modes, it will instead run at the speed set here.

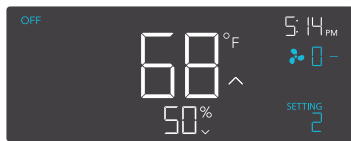

ON MODE

Your fan will actively run at the speed set here, regardless of the probe's reading. The ON mode also serves as the maximum speed setting the other modes will run in.

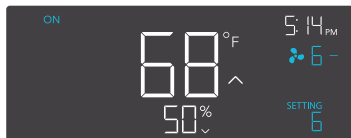

AUTO MODE (HIGH TEMPERATURE TRIGGER)

Pressing the up or down button sets the high temperature trigger. The fans will activate if the probe's reading meets or exceeds this threshold.

Once triggered, the fan will gradually ramp up to the speed set in ON mode. If the probe's reading falls below this trigger point, the fans will gradually slow down to a stop or at the speed set in OFF mode.

You may set this trigger below the low temperature trigger to create a specific range in which the fan is active.

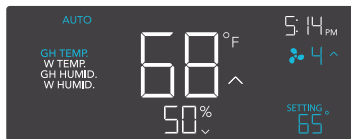

Note that this trigger can activate as long as you are in AUTO Mode, even if you are viewing a different trigger within AUTO Mode.

If there is a speed set in OFF Mode other than zero, the fans will run at that speed when triggered to turn off.

PROGRAMMING

AUTO MODE (LOW TEMPERATURE TRIGGER)

Pressing the up or down button sets the low temperature trigger. The fans will activate if the probe's reading meets or falls below this threshold.

Once triggered, the fan will gradually ramp up to the speed set in ON mode. If the probe's reading rises above this trigger point, the fans will gradually slow down to a stop or at the speed set in OFF mode.

You may set this trigger above the high temperature trigger to create a specific range in which the fan is active.

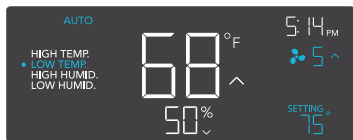

Note that this trigger can activate as long as you are in AUTO Mode, even if you are viewing a different trigger within AUTO Mode.

If there is a speed set in OFF Mode other than zero, the fans will run at that speed when triggered to turn off.

TRIGGER MODE: (HIGH HUMIDITY TRIGGER)

Pressing the up or down button sets the high humidity trigger. The fans will activate if the probe's reading meets or exceeds this threshold.

Once triggered, the fan will gradually ramp up to the speed set in ON mode. If the probe's reading falls below this trigger point, the fans will gradually slow down to a stop or at the speed set in OFF mode.

You may set this trigger below the low humidity trigger to create a specific range in which the fan is active.

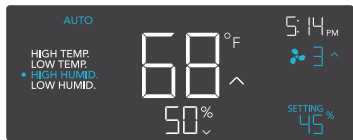

Note that this trigger can activate as long as you are in AUTO Mode, even if you are viewing a different trigger within AUTO Mode.

If there is a speed set in OFF Mode other than zero, the fans will run at that speed when triggered to turn off.

PROGRAMMING

AUTO MODE (LOW HUMIDITY TRIGGER)

Pressing the up or down button sets the low humidity trigger. The fans will activate if the probe's reading meets or falls below this threshold.

Once triggered, the fan will gradually ramp up to the speed set in ON mode. If the probe's reading rises above this trigger point, the fans will gradually slow down to a stop or at the speed set in OFF Mode.

You may set this trigger above the high humidity trigger to create a range in which the fan is active.

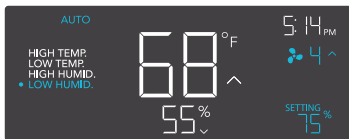

Note that this trigger can activate as long as you are in AUTO Mode, even if you are viewing a different trigger within AUTO Mode.

If there is a speed set in OFF Mode other than zero, the fans will run at that speed when triggered to turn off.

TIMER TO ON MODE

Pressing the up or down button sets a countdown time. Once the timer ends, the fans will trigger to run at the speed set in ON Mode. If there is a speed set in OFF Mode, the fans will run at that speed during the countdown.

The countdown will begin if no buttons are pressed for 5 seconds. The time left on the countdown is displayed below the current fan speed. Leaving the timer mode while the countdown is running will pause it until you return to this mode.

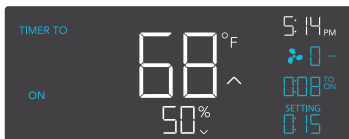

If there is a speed set in OFF Mode other than zero, the fans will run at that speed when triggered to turn off.

PROGRAMMING

TIMER TO OFF MODE

Pressing the up or down button sets a countdown time. The fans will run at the speed set in ON Mode until the countdown ends. If there is a speed set in OFF Mode, the fans will run at that speed after the end of the countdown.

The countdown will begin if no buttons are pressed for 5 seconds. The time left on the countdown is displayed below the current fan speed. Leaving the timer mode while the countdown is running will pause it until you return to this mode.

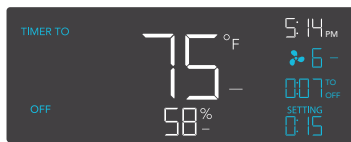

If there is a speed set in OFF Mode other than zero, the fans will run at that speed when triggered to turn off.

CYCLE MODE (ON AND OFF)

Set an on duration and an off duration for the fan to cycle through continuously. Press the up or down button to first set a duration for the fan to activate. Then press the mode button again and set a duration for the fan to deactivate. When the fan is activated, it will run at the speed set in ON Mode. When the fan is deactivated, it will run at the speed set in OFF Mode.

The countdown will begin if no buttons are pressed for 5 seconds. The time left on the countdown before the next on or off phase is displayed below the current fan speed. Leaving the cycle mode while the countdown is running will pause it until you return to this mode.

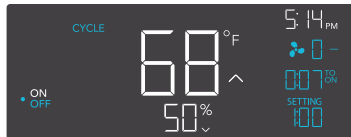
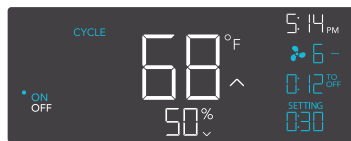

If there is a speed set in OFF Mode other than zero, the fans will run at that speed when triggered to turn off.

PROGRAMMING

SCHEDULE MODE (ON AND OFF)

Sets an on clock-time and an off clock-time schedule for the fan to follow daily. Press the up or down button to first set up an on clock-time to trigger ON mode, then press the mode button to set an off clock-time to trigger OFF mode. Please be sure to set the current clock time under settings.

When the fan is triggered to activate, it will run at the speed set in ON Mode. When the fan is triggered to deactivate, it will run at the speed set in OFF Mode.

The countdown will begin if no buttons are pressed for 5 seconds. The time left on the countdown before the next on or off phase is displayed below the current fan speed. The fan will not follow this schedule if you leave this mode. If you re-enter the Schedule Mode, it will continue to follow the latest schedule you have set.

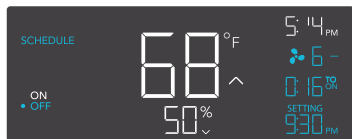
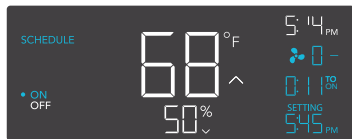

If there is a speed set in OFF Mode other than zero, the fans will run at that speed when triggered to turn off.

PROGRAMMING

CONTROLLER SETTINGS

Pressing the setting button will cycle through the controller's available settings: DISPLAY, °F/°C, CLOCK, CALIB. T°, CALIB. H%, TRANS. T°, and TRANS. H%.

DISPLAY SETTING

Adjusts the display brightness and auto-dimming. Press the up or down button to cycle through levels 1, 2, 3, A2 and A3; 3 being the highest brightness setting, while 1 is the lowest. In settings 1, 2 and 3, the display will stay at that brightness level and will not automatically dim the display.

A2 and A3 will set the brightness level at 2 and 3, respectively, and will dim down the brightness level 1 when the controller is not being used after 15 seconds.

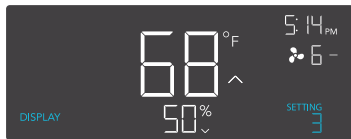

TOGGLING THE DISPLAY

Lock the controller by holding the setting button.

Press the setting button to turn the display off. Pressing the setting button again will turn the display back on.

Programs will still run in the background while the LCD screen is off.

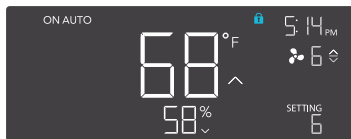

PROGRAMMING

°F/°C SETTING

Changes the displayed units to Fahrenheit or Celsius. Press the up or down button to cycle through F and C. All displayed units will automatically convert when adjusting this setting.

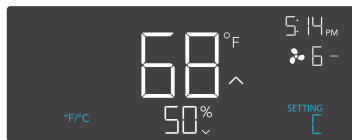

CLOCK SETTING

Adjusts the current clock time. Press the up or down button to increase or decrease the time. Once you cycle through 12:00 each time, the units will automatically change to AM or PM. The clock time is located at the top right corner of the display.

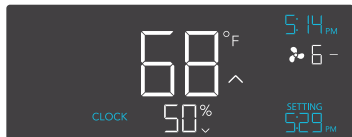

PROGRAMMING

CALIBRATION TEMPERATURE SETTING

Adjusts the temperature reading the sensor probe is measuring. Press the up or down button to increase or decrease the data figure in 2°F (or 1°C) increments. The calibration cycle ranges from -8°F to 8°F (or -4°C to 4°C) and will be applied to the sensor probe's measurements.

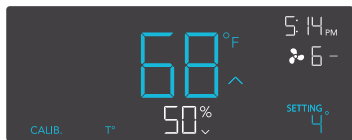

CALIBRATION HUMIDITY SETTING

Adjusts the relative humidity reading the sensor probe is measuring. Press the up or down button to increase or decrease the data figure in 1% increments. The calibration cycle ranges from -8% to 8% and will be applied to the sensor probe's measurements.

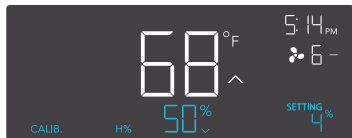

PROGRAMMING

TRANSITION TEMPERATURE SETTING

Adjusts the transition threshold between the fan speeds in the AUTO Mode temperature triggers.

Press the up or down button to cycle through 0°F to 8°F (0°C to 4°C) and set a transition threshold. The fan speed will be set one level above the OFF Mode speed when the sensor temperature first meets or exceeds the high temperature trigger. For every transition threshold crossed, the fan speed will ramp up by one speed level, up until it reaches the speed set in ON Mode.

In this example, your high temperature trigger is set at 80°F, the OFF Mode speed is 0, and the ON Mode speed is 6. If the transition threshold is set to 0°F, then the fan will trigger to run at speed 6 when the sensor temperature meets or exceeds 80°F. However, if the transition threshold is set to 2°F, then the fan will trigger to run at speed 1 when it meets or exceeds 80°F. It will then step up to speed 2 when meeting or exceeding 82°F, speed 3 at 84°F, speed 4 at 86°F, and speed 5 at 88°F. From 90°F on, it will run at speed 6, the speed set in ON Mode.

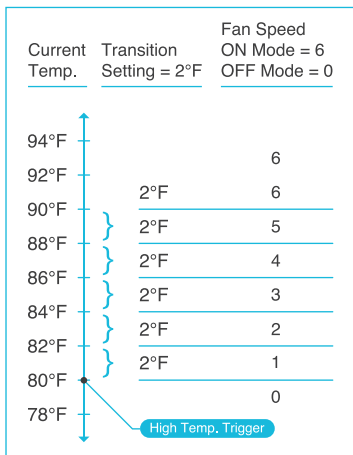
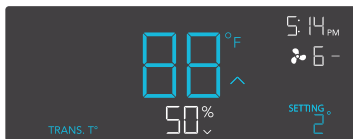

PROGRAMMING

TRANSITION HUMIDITY SETTING

Adjusts the transition threshold between the fan speeds in the AUTO Mode humidity triggers.

Press the up or down button to cycle through 0% to 8% to set a transition threshold. The fan speed will be set one level above the OFF Mode speed when the sensor humidity first meets or exceeds the high humidity trigger. For every transition threshold crossed, the fan speed will ramp up by one speed level, up until it reaches the speed set in ON Mode.

In this example, your high humidity trigger is set at 67%, the OFF Mode speed is 2, and the ON Mode speed is 7. If the transition threshold is set to 0%, then the fan will trigger to run at speed 7 when the sensor humidity meets or exceeds 67%. However, if the transition threshold is set to 5%, then the fan will trigger to run at speed 3 when it meets or exceeds 67%. It will then step up to speed 4 when meeting or exceeding 72%, speed 5 at 77%, and speed 6 at 82%. From 87% on, it will run at speed 7, the speed set in ON Mode.

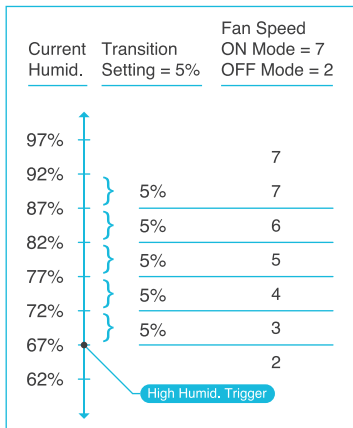

PROGRAMMING

ALERT ICONS

The alert icons are displayed at the top of the screen. Icons may flash when the controller signals an alert to notify you of any triggered function or alarm.

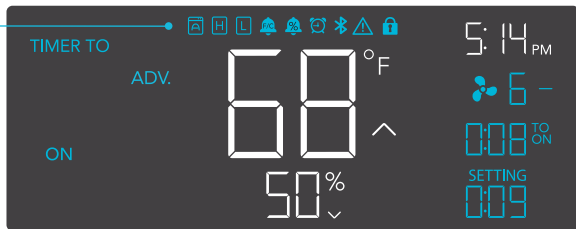

ADVANCE PROGRAMMING

Displays when an advance program set in the app is active. "ADV." will appear and override the controller if an automation program is in use.



HIGH TEMPERATURE ALARM

Flashes and beeps with an alert if the temperature rises above the trigger point set in the app. Continues to flash until the temperature falls below the trigger point.



LOW TEMPERATURE ALARM

Flashes and beeps with an alert if the temperature falls below the trigger point set in the app. Continues to flash until the temperature rises above the trigger point.



HIGH HUMIDITY ALARM

Flashes and beeps with an alert if the humidity rises above the trigger point set in the app. Continues to flash until the humidity falls below the trigger point.

PROGRAMMING

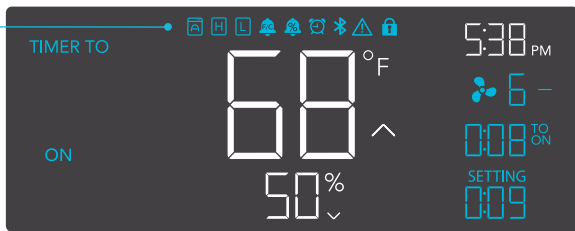

LOW HUMIDITY ALARM

Flashes and beeps with an alert if the humidity falls below the trigger point set in the app. Continues to flash until the humidity rises above the trigger point.



TIMER ALERT

Flashes when a countdown has completed for TIMER TO ON, TIMER TO OFF, CYCLE, or SCHEDULE Mode.



BLUETOOTH

Appears when the physical controller is connected to the app via Bluetooth.



CHECK FAN ALERT

Flashes when the fan's probe senses interference to its functioning. Check the fan for possible issues. If the fan is not working, please see the warranty page for replacement information.



DISPLAY LOCK ALERT

Displays when you lock the controller. The icon will flash and beep if you attempt to adjust the controller while it is still locked.

OTHER SETTINGS

FACTORY RESET

Holding the mode, up, and down buttons together for 5 seconds will reset your controller and restore factory settings. This clears all user parameters in each controller mode and setting.

HOLD +   

CONTROLLER LOCK

Holding the setting button will lock the controller in your current mode. While your controller is locked, no parameters may be adjusted, nor will you be able to switch modes. Holding the power button again will unlock the controller.

HOLD + 

HIDE SCREEN

Lock the controller so no settings can be adjusted. See above. Then press the setting button to turn the display off. Pressing it again will turn the display back on. Programs will still run in the background while the LCD screen is off.

PRESS + 

JUMP TO OFF MODE

Holding the mode button for 3 seconds while in any mode or setting will automatically jump to OFF Mode. This function is disabled if the controller is locked.

HOLD + 

RESET TO OFF OR ZERO (0)

Holding the up and down buttons together for 2 seconds will reset the value of your current mode to OFF or 0. Pressing either the up or down button will return the value to the mode's last setting.

HOLD +  

AUTO INCREASING OR DECREASING

Holding the up or down button will increase or decrease the user setting automatically until you release them.

HOLD + 

HOLD + 

DOWNLOAD THE APP

THE AC INFINITY APP

The AC Infinity app enables you to connect with the next generation of our intelligent controllers, giving you access to advance programs and environmental data.

1

Download the AC Infinity app from the App Store or Play Store.



2

Open the AC Infinity app. Follow the instructions in the app to pair your controller with the app.



3

Scan the QR code below or visit our website at www.acinfinity.com for more information on the AC Infinity app.



ADD A DEVICE

1

Connect the fan and probe into your controller. Plug the fan into a wall outlet.

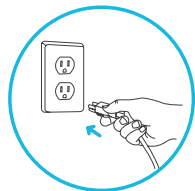
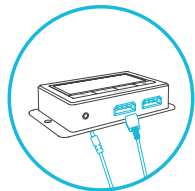

2

Launch the app. Tap the (+) button, then "SMART CONTROLLERS", and select CONTROLLER 67 to begin pairing.

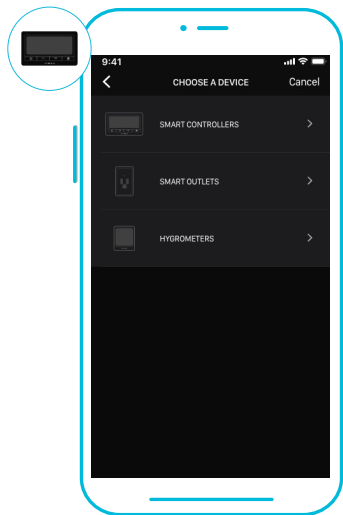

Please note: Bluetooth must be enabled on your mobile device before starting the pairing process.

ADD A DEVICE

3

Tap DONE button to complete the pairing process.

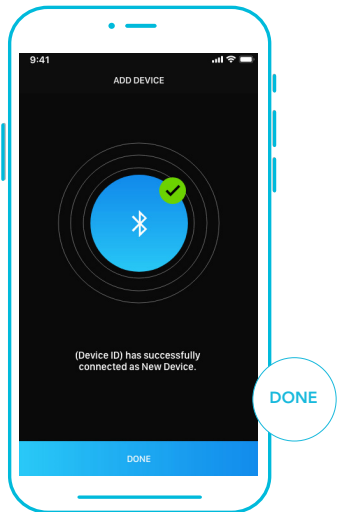

4

Your controller will appear in your smart device with a unique ID.

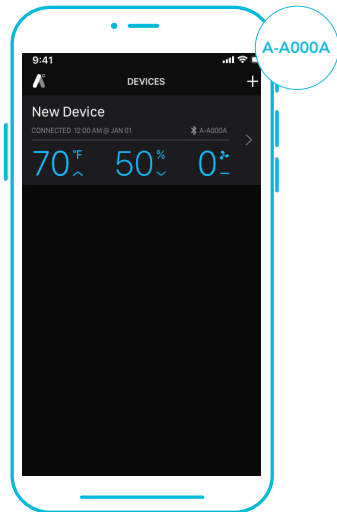

Please note: When pairing the app around multiple controllers, move your mobile device closer to your desired controller.

APP PROGRAMMING

1. MODE BUTTON

Dropdown displays all available controller modes: OFF, ON, AUTO, TIMER TO ON, TIMER TO OFF, CYCLE, and SCHEDULE.

4. CONNECTION STATUS

Displays the last time and date the app is paired with the controller and whether or not they are currently connected.

6. SLIDERS

Adjusts the setting of your current mode. Slide left to decrease and slight right to increase. The (+/-) steppers may also be used.

8. ADV. PROGRAMMING

Creates automated activations, alarms, and push notifications.

10. HISTORY LOG

Logs all advance programming notifications and controller activity. Can be filtered by controller functions.

2. TEMPERATURE/HUMIDITY

Toggles between current temperature and humidity readings.

3. SETTINGS

Adjusts app settings including Device Name, Temperature Display, Device Brightness, Fan Speed Transitions, and Calibrations.

5. CONTROL WHEEL

Lays out your current mode's controls and displays temperature/humidity, current settings, and time.

7. CONTROLS TAB

Gives access to the controller mode dashboard, control wheel, mode button, temperature/humidity button, and sliders.

9. DATA TAB

Logs and stores all temperature and humidity information. Tracks trends and distribution. Data can be sorted by hour, day, week, month, and year.

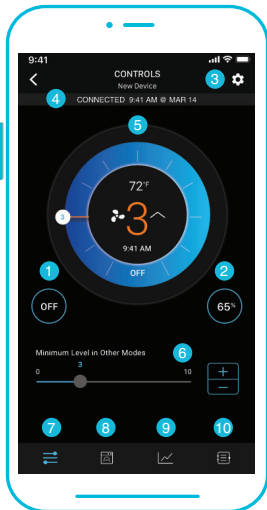

APP PROGRAMMING

CONTROLS TAB

Contains all controller modes including the OFF, ON, AUTO, TIMER TO ON, TIMER TO OFF, CYCLE and SCHEDULE modes.

1

Tap the paired device to enter the Controls tab, where you can adjust the controller modes.

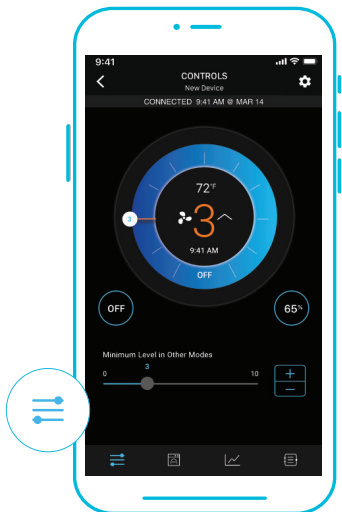

2

Tap the menu button to access the controller modes. Tap the temperature/humidity button to switch between readings.

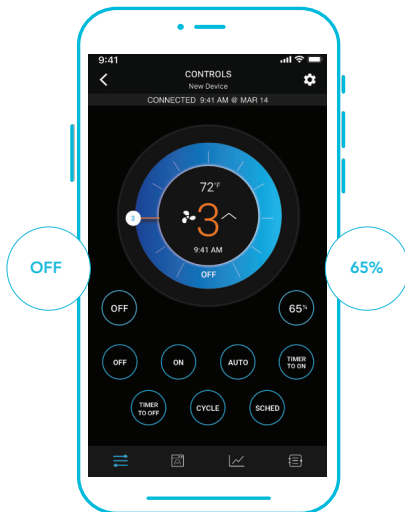

APP PROGRAMMING

CONTROLS TAB

The control wheel displays the temperature/humidity, current settings, and time.

3

Use the wheel hands, (+/-) stepper, or sliders to set your parameters.

4

Use the toggle switch to activate or deactivate any climate triggers.



APP PROGRAMMING

ADVANCE PROGRAMMING

Creates automated activations, alarms, and push notifications. The adjustable modes in each program include those listed in controls tab.

Once an advance program completes its programming (i.e. scheduling), the app will no longer override the controller's onboard settings. Only when the advance program activates will the app override the controller.

Programs can be edited by tapping on them, deactivated by tapping on the toggle switch, or deleted by swiping right and tapping DELETE.

All activity is logged in the History Logs tab.

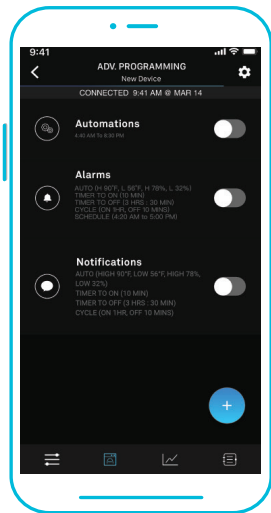

APP PROGRAMMING

ADVANCE PROGRAMMING - AUTOMATION

Each automation can support one mode at a time. To automate multiple modes, you must create additional programs, except for TIMER TO ON and TIMER TO OFF in automation. The app will override the controller while an automation is active.

1

Tap the (+) button to create an automation program.

Set a start time and end time using the time picker. Then select your desired mode to trigger. Choose between ON mode, OFF mode, CYCLE mode, or Temperature and Humidity.

When selecting CYCLE mode, use the sliders to set your CYCLE ON and CYCLE OFF timers.

When selecting Temperature and Humidity, use the sliders to select and the toggle switch to activate or deactivate them.

Tap CONFIRM to save the program.

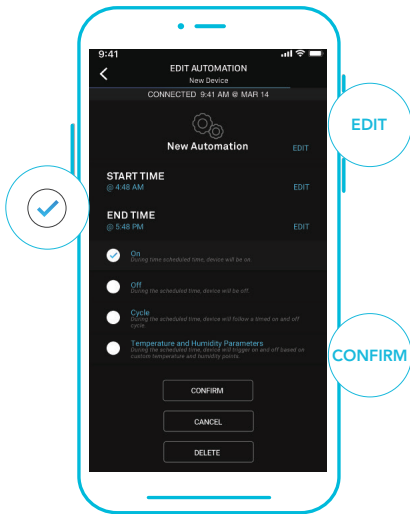

APP PROGRAMMING

ADVANCE PROGRAMMING - ALARMS

Alarms will tell your controller to beep whenever your fan switches on or off as a result of the mode(s) you select in the program. Choose between AUTO, TIMER TO ON, TIMER TO OFF, CYCLE and SCHEDULE modes. Alarm programming will also have a climate points setting in which the alarm will go off when temperature and humidity hits a high or low point.

2

Tap the (+) button to create an alarm program. You may select multiple modes to trigger an alarm in a single program.

When selecting Temperature and Humidity, use the sliders to select and the toggle switch to activate or deactivate them.

You may edit the name of the program by tapping EDIT.

Tap CONFIRM to save the program.

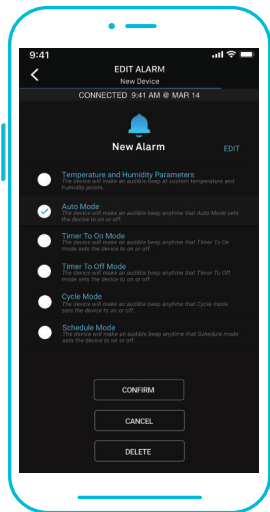

APP PROGRAMMING

ADVANCE PROGRAMMING - NOTIFICATIONS

Notification programs will send push notifications to your mobile device whenever your fan switches on or off as a result of the mode(s) you select in the program. Choose between AUTO, TIMER TO ON, TIMER TO OFF, CYCLE and SCHEDULE modes.

Notification programming will also have a climate points setting in which you receive push notifications when temperature and humidity hits a high or low point.

3

Tap the (+) button to create a notification program. You may select multiple modes to trigger an alarm in a single program.

When selecting Temperature and Humidity, use the sliders to select and the toggle switch to activate or deactivate them.

You may edit the name of the program by tapping EDIT.

Tap CONFIRM to save the program.

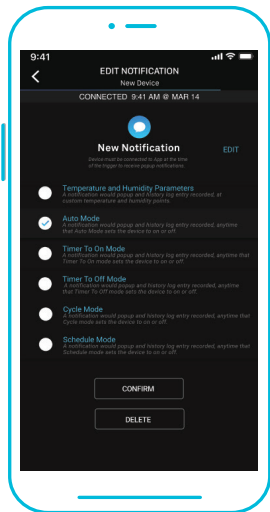

APP PROGRAMMING

DATA TAB

Logs and stores all temperature and humidity information. Readings are displayed in fluctuation charts and bar graphs and can be viewed in hours, days, weeks, months, and years. Data can be exported as a spreadsheet and sent to other devices by tapping EXPORT CSV DATA.

1

The Fluctuation Charts readout displays the detected temperature or humidity over a given timespan. Swipe left or right to scroll through the readings. As you scroll, the dotted line will move up or down and display the average reading of the timespan you selected.

The maximum reading of the given time span is displayed at the top of the chart, while the minimum reading is displayed at the bottom of the chart.

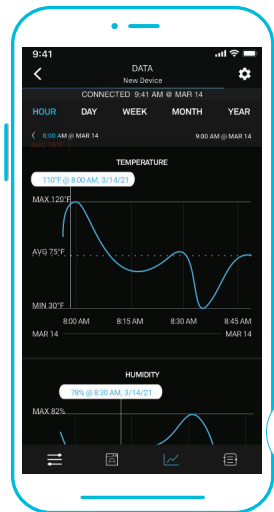

APP PROGRAMMING

DATA TAB

The fluctuation charts and bar graphs allow you to see trends in temperature and humidity and enable you to make the necessary adjustments to your space. Tap on any point in the charts and graphs to see detailed information on the picket.

2

Bar Graphs - This readout displays how often a detected temperature or humidity point occurs over a given timespan.

The minimum and maximum readings of the given timespan are displayed at the top of the graph.



APP PROGRAMMING

HISTORY LOG

Logs all advance programming notifications and controller activity. Entries can be filtered by controller functions and programming including triggers, timers, cycles, schedules, automation, alarms, and notifications.

1

Swipe up and down to scroll through the history log.



2

Tap "SHOW FILTERS" to reveal activity options. Unchecked functions will filter them from the log.



APP SETTINGS

SETTINGS

Tap the gear icon to access the settings. Sets all controller-related parameters including Device Name, Temperature Display, Screen Brightness, Transitions, and Calibrations. Tap CONFIRM to save your settings. Tapping CANCEL will leave the settings menu without saving changes. Tapping DELETE DEVICE will unpair your controller from the app.

DEVICE NAME

Supports a maximum of 20 characters.

TEMPERATURE DISPLAY

Toggles between Celsius and Fahrenheit scales.

DEVICE BRIGHTNESS

Sets the controller screen brightness using three standard levels [1, 2, and 3] and two auto-dimming levels [A2 and A3].

TRANSITION TEMPERATURE AND HUMIDITY

Adjusts the degree to which the fan speed steps up or down in level. The fan speed will change by one for every multiple of this transition setting between the set and current climate condition.

CALIBRATION TEMPERATURE AND HUMIDITY

Adjusts the controller's temperature and humidity readings to match your other measuring device's readings. The calibration will apply the changes on the app and the controller.

CLOUDLINE FAQ

Q: I am missing my controller. It wasn't included in my package!

A: Please refer to page 7 for an image of what your controller should look like. Your controller should be neatly slotted in the box by this product manual.

Q: Where is the best place to position the sensor probe?

A: Place the sensor probe as close as possible to the hottest or most humid spot in your space.

Q: Do I need to remove the plastic cap from the probe?

A: Yes. You will need to remove the plastic cap so the probe can accurately read climate conditions.

Q: Can I mount this inline duct fan vertically?

A: Yes. The CLOUDLINE can be mounted in any orientation, including vertically.

Q: Will I be able to hardwire this fan to my own controller or thermostat?

A: We do not recommend hardwiring or splicing our fan's power wires. Such modifications may compromise electrical safety and will void this product's warranty.

Q: Do I need to use a power converter if I'm outside the US?

A: This product's voltage range is 100-240V AC. You may need a simple travel adapter to plug it into a foreign socket, or a power converter if your country uses a different voltage.

CLOUDLINE FAQ

Q: Does the controller retain its settings after power is shut off?

A: Yes. If the controller's power is cut off and is powered on afterwards, your settings will remain.

Q: What is the CFM of each of the different fan speeds?

A: Please refer to your CLOUDLINE model's product listing for its CFM specification.

Q: I'm not getting enough airflow even after setting the fan speed to 10. What can I do?

A: Bends in ducting will reduce your fan's CFM performance. To retain airflow, you may straighten the ducting and eliminate as many bends as possible.

Q: Should I use this inline duct fan as an intake or an exhaust fan?

A: The CLOUDLINE is primarily used as an exhaust fan, but can be used as an intake fan as well. You may use this fan as an intake fan if you need fresh air into your space.

Q: Can I connect different sized fans to the same controller?

A: Please refer to page 23 for details on daisy chaining fans together.

Q: I'm hanging my fan upside down in my grow tent, can I rotate its motor box plate?

A: Yes. Use a screwdriver to unscrew the motor cap. Rotate it to your desired orientation and reapply the screws.

AC INFINITY PRODUCTS

Advance Grow Tents

The CLOUDLAB series is a line of grow tents designed to create ideal growing conditions and facilitate indoor plant cultivation year-round. Features 2000D thick oxford canvas lined with inner diamond patterned mylar that maximizes grow light luminosity, and a reinforced frame with 150 lb. weight capacity. Includes a mounting plate to install your AC Infinity controller onto.

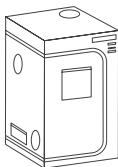

Carbon Filters

The duct carbon filter is designed to eliminate odors and chemicals for grow tents and hydroponic spaces. It utilizes premium grade Australian charcoal that features greater absorption power and a longer lifespan. Enables maximum airflow pass through as part of an intake or an exhaust system.

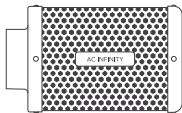

Ducting Tubes

The four-layer ducting tube is used to direct airflow, designed for ventilation systems in applications like HVAC, dryers, and grow rooms. It is highly durable and flexible, and can be used anywhere from tight spaces to wide open areas.

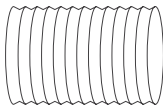

Discover the latest innovations in cooling and ventilation at acinfinity.com

WARRANTY

This warranty program is our commitment to you, the product sold by AC Infinity will be free from defects in manufacturing for a period of two years from the date of purchase. If a product is found to have a defect in material or workmanship, we will take the appropriate actions defined in this warranty to resolve any issues.

The warranty program applies to any order, purchase, receipt, or use of any products sold by AC Infinity or our authorized dealerships. The program covers products that have become defective, malfunctioned, or expressively if the product becomes unusable. The warranty program goes into effect on the date of purchase. The program will expire two years from the date of purchase. If your product becomes defective during that period, AC Infinity will replace your product with a new one or issue you a full refund.

The warranty program does not cover abuse or misuse. This includes physical damage, submersion of the product in water, incorrect installation such as wrong voltage input, and misuse for any reason other than intended purposes. AC Infinity is not responsible for consequential loss or incidental damages of any nature caused by the product. We will not warrant damage from normal wear such as scratches and dings.

To initiate a product warranty claim, please contact our customer service team at support@acinfinity.com



If you have any issues with this product, contact us and we'll happily resolve your problem or issue a full refund!

COPYRIGHT © 2021 AC INFINITY INC. ALL RIGHTS RESERVED

No part of the materials including graphics or logos available in this booklet may be copied, photocopied, reproduced, translated or reduced to any electronic medium or machine readable form, in whole or in part, without specific permission from AC Infinity Inc.

www.acinfinity.com